

LAWA & LAWA PLUS

CONVENTIONAL COMBI BOILERS
INSTALLATION & USER MANUAL



Lawa



LawaPlus

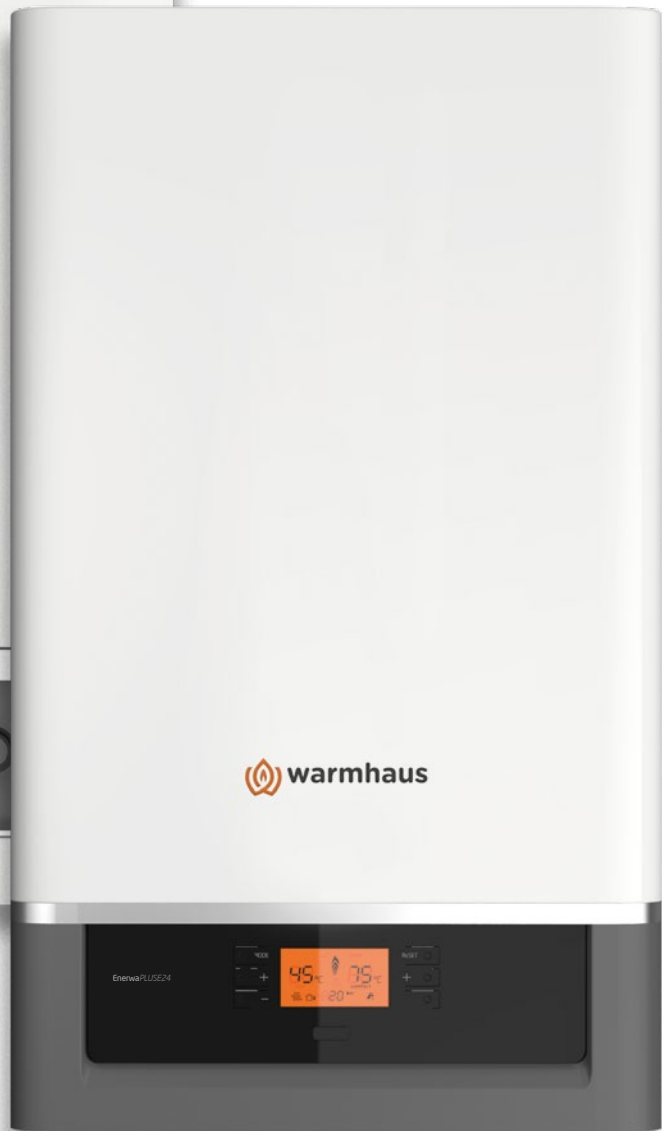



INDEX

1.	DEAR WARMHAUS CUSTOMER	4
1.1.	GENERAL WARNINGS.....	4
1.2.	GENERAL WARRANTY CONDITIONS.....	4
1.3.	GAS LEAKAGES.....	5
2.	INSTALLATION PERSONNEL SECTION.....	5
2.1.	CONTENTS OF PACKING BOX	5
2.2.	COMBI INSTALLATION RULES	6
2.2.1.	General Rules for Installation Places of Combi Boilers.....	6
2.2.2.	Places Not Suitable for Installing Hermetical Combi Boilers.....	6
2.2.3.	Wall Installation of Combi and Selecting the Installation Place	6
2.2.4.	Dimensions and Connections.....	6
2.2.5.	Natural Gas and LPG Connection (Device Category I2H, I2H3P).....	7
2.2.6.	Flammable Gas Quality	7
2.2.7.	In Case of Using LPG Tank	7
2.2.8.	In Case of Using Bottled Gas.....	7
2.2.9.	Radiator and Domestic Hot Water Installations	8
2.2.10.	Exhaust Gas Flue Pipe Set and Accessories Connection	8
2.2.11.	Peripheral Distances of Flue Output Connections	8
2.2.12.	Flue Accessories.....	9
2.2.13.	Installation with Horizontal Flue Sets (Ø60/100 mm).....	10
2.2.14.	Installation with Horizontal Flue Sets	11
2.2.15.	Hermetic Flue Type Use.....	12
2.2.16.	Installation at Partially Protected Exteriors	12
2.2.17.	Electrical Connections.....	12
2.2.18.	Optional Controls: Room Thermostat, External Weather Temperature Sensor and Others	13
2.3.	HYDRAULIC INSTALLATION RULES	
2.3.1.	Radiator (Heating) Water Structure.....	14
2.3.2.	Filling/Emptying Radiator Installation	14
2.3.3.	Circulation Pump.....	14
2.3.4.	Controls for Initial Operation of Combi.....	14
3.	USER SECTION	15
3.1.	GENERAL WARNINGS FOR USER	15
3.1.1.	Use of Combi.....	15
3.2.	SELECTION OF ON/OFF/STANDBY AND SUMMER/WINTER MODES	17
3.2.1.	On/Off/Standby Positions.....	17
3.2.2.	Operation at Winter Position	17
3.2.3.	Operation at Summer Position	17
3.2.4.	Resetting the Combi (Re-Starting)	17
3.2.5.	Shutting OFF the Combi.....	17
3.2.6.	Selection of On/Off/Standby and Summer/Winter Modes.....	19
3.2.7.	On/Off/Standby Positions.....	19
3.2.8.	Operation at Winter Position	19
3.2.9.	Operation at Summer Position	19
3.2.10.	Shutting Off the Combi.....	20
3.2.11.	Use with Room Thermostat (Optional).....	20
3.2.12.	External Weather Temperature Sensor Use (Optional).....	20
3.2.13.	Customizing Combi Features	21
4.	TROUBLESHOOTING.....	21
4.1.	FAILURE CODES TABLE.....	21
4.3.	ISSUES REQUIRED TO BE TAKEN INTO CONSIDERATION FOR WARRANTY CONDITIONS.....	23



1. DEAR WARMHAUS CUSTOMER

We congratulate you for preferring the Warmhaus combi to maintain your heating and domestic hot water comfort for long years and thank for your trust. Warmhaus combi, manufactured in accordance with European Union standards and advanced technology, are also being imported to many countries. You can benefit from our Authorized Technical Service network having occupational competency certificate for all kinds of ordinary maintenance requirements for this product manufactured with rigorous studies. Our Authorized Services guarantee protection of your device performance as they always provide original spare parts service. Carefully read this guide in order to use the combi in an economic, comfortable and efficient way and keep as a source of application.

In order to ensure efficient use, we initially recommend you to have the installation performed by a certified dealer experienced and competent in installation by the local gas authority.

1.1. GENERAL WARNINGS

Guide Book is an inseparable and integral part of the product and should be delivered to the new user when the device is transferred. The aforementioned book should be carefully protected and used as well as be applicable when required as it contains important information regarding installation.



Radiator and DHW installations should be engineered and produced by a competent and certified engineering company in accordance with measurements defined based on laws by considering legal regulations in force.



Installation and Maintenance operations should be performed by the expert personnel having adequate technical knowledge in installations sector and occupational competency certificate in accordance with legal regulations in force. As the result of a false installation, dangers may occur which the manufacturer company cannot be held responsible for and may damage people, other live beings (animals, plants) or commodities.



Natural Gas Installation Project; One of the dealers authorized by a gas company located at your city should be preferred for performing project and etude studies.



In order to enable use of the combi with LPG tubes or LPG tanks, conversation of the combi should be performed by our authorized Warmhaus service. Project design and application for LPG use should be performed by the company supplying the tank in accordance with local and legal rules.

1.2. GENERAL WARRANTY CONDITIONS



The Manufacturer company shall not have any responsibilities within or out of the agreement scope due to failures arising from failing to follow legal regulations in force and standards and information given in this guide book (and information and instructions provided by the manufacturer under any circumstances) during installation, use or maintenance operations and device warranty shall also be void.



Only the authorized Warmhaus Service is authorized to make the electrical connection of Combi and supplying electricity to the combi.

The maintenance and repairs as the result of failure of the product within the warranty period due to material, production and installation errors shall be performed as free of charge without claiming any workmanship costs and spare part payments.



This device should only be used for its designed intended purposes (to be used in closed-circuit heater installation and production of open circuit domestic hot water production). All kinds of other uses are not suitable as well as may create a potential danger.

Manufacturer shall not be responsible for damages occurring due to interventions, false installation and initial starting performed by unauthorized persons and warranty scope shall be void. As the Combi is a device having heating system, domestic hot water, natural gas/LPG and electrical connections, do not make and have any interventions made without the authorized service.



Device maintenance operations should be performed by the authorized and expert technical personnel, and



It is strictly forbidden to try to detect the gas leakage with the help of flame.



This device has been manufactured to be installed in the country given on the technical registry label. Performing the installation in countries other than the country written on the table may damage individuals, animals and commodities.



Connections sealed with bolt paint must not be opened or changed by a person who is absolutely expert and not approved service. These seals prove that the bolts required for perfect and safe operation have not been changed. If the seals are damaged, the guarantee of the device will come to an end!

Combi boilers bear CE mark in accordance with below given directives:
- Gas Directive 2009/142/EEC
- Efficiency Directive 92/42/EEC
- Electromagnetic compatibility
- Directive 2014/30/EU

Please visit the below given web site of Warmhaus for acquiring more detailed information regarding legal regulations on installation of gas fired heating devices: www.warmhaus.com

Manufacturer: WARMHAUS Isıtma ve Soğutma Sistemleri Tic. A.Ş. Bursa Organize Sanayi Bölgesi Park Cad. No:10 16140 Nilüfer-Bursa / Türkiye

WARMHAUS

Warmhaus Authorized Technical Service Centres maintain an assurance regarding quality and professionalism on that issue. WARMHAUS is not responsible for damages arising from repairs, part replacements and maintenances performed by third persons and companies and combi remains out of the warranty scope under such conditions.









WARMHAUS A.Ş. reserves the right to make all kinds of technical and commercial amendments without giving information and rejects all responsibilities depending on misspelling.

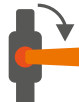

1.3. GAS LEAKAGES

HOW TO MOVE WHEN NATURAL GAS ODOUR IS DETECTED...

 Do not use lighter - matches.	 Do not light on and off lamps and other electrical devices or pull off the plug.	 Ventilate the environment by opening doors and windows.	 Close valves of devices operating with natural gas and your gas meter.	 Do not use the door bell.
 Do not use phones in case of a natural gas leakage. It may create sparks.	 Immediately evacuate the place with gas odour.	 Natural Gas Emergency Line from your neighbour or another suitable place.	 Do not make any intervention on installation.	 Never close culverts ensuring discharge of the gas from the environment in case of a natural gas leakage.

DURING EMERGENCIES

 NATURAL GAS EMERGENCY	 FIRE DEPARTMENT
 AMBULANCE	 POLICE

INFORMATION: You can visit web sites of local gas authorities and **NATURAL GAS EMERGENCY** sections.

Advice: Please take note local emergency phone numbers.

2. INSTALLATION PERSONNEL SECTION

2.1. CONTENTS OF PACKING BOX

Warmhaus is sold as two boxes containing combi and flue set. Combi box contains below listed materials and smaller box contains exhaust gas flue pipes.

- I. Installation Scheme (Figure 1)
- II. User Guide (Figure 2)
- III. Connection Accessories (Figure 3)
 - a. 1 Throttle screw (installed at flue output).
 - b. 2 Hanger screws
 - c. 2 Dowels
- IV. Hanger Plate (Figure 4)
- V. Exhaust Gas Flue Set (Figure 5)

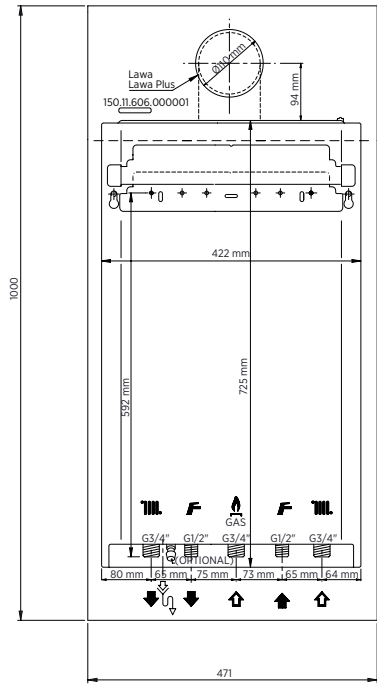

Figure 1 Installation scheme



Figure 2 Installation Notes



Figure 3 Connection accessories



Figure 4 Hanger plate



Figure 5 Exhaust gas flue set

 Do not leave packing materials (plastic, nylon, bags, etc.) within a child's reach - be safe.



2.2. COMBI INSTALLATION RULES

2.2.1. General Rules for Installation Places of Combi Boilers

No restriction is available for places where Hermetic (C type) combi is installed (devices may be installed regardless of the room volume and ventilation type). Also, they may be installed in partially protected areas such as balconies, terraces provided that precautions are taken to ensure boiler is frost proof. Combi should be soundly installed against a building wall. A flexible connection piece should be used between the combi and gas line. Flex lengths to be used in A, B and C type devices should not exceed dimensions allowed by local gas authorities. Flue outputs of hermetic combi boilers must be connected to ventilated places with air circulation. Installation (positions of pipe output opening based on various forms, vertical, horizontal minimum distances, cross section areas of channels if given to channels, etc.) must be carried out according to regulation standards, current legislation and in compliance with local technical regulations and the required technical procedures.

2.2.2. Places Not Suitable for Installing Hermetical Combi Boilers

- Stairways of Buildings,
- Corridors available for general use, ventilation ways and shafts, lofts, attics, emergency exit doors, cellars, hall and similar communal use areas,
- Yards between buildings,
- Narrow cornices
- Over flue walls,
- Enclosed balconies,
- Open balconies (except being located in a cabinet approved by the device company),
- Below protruding structure parts preventing exhaust gas output,
- Places directly subjected to wind resistance,
- It is forbidden to install Hermetic combi (C type) in openings providing clean air to other units.

2.2.3. Wall Installation of Combi and Selecting the Installation Place

- Wall installation for the combi boiler should be well secured.
- The hanger plate given as standard with the combi should be installed according to the technique to a full or semi-full brick wall according to installation scheme and with connection screws and not to be used for other purposes.
- If different materials are used for installation, the combi shall be rendered out of the warranty scope.
- If the wall of installation is not a brick wall, additional support will be required..
- Combi should be installed on a wall resistant to fire.
- 1,8 - 2,2 m height is recommended for installation of the combi hanger plate.
- For places with limited installation space, combi should be installed at minimum of 30 cm height from ground and by leaving at least 5 cm distance from both sides in order to allow easy access for the service technician.
- Combi installation must not performed in environments containing explosive, flammable substances and acid fumes.
- Installation cannot be made near or ovens, radiators or heater devices.
- Hermetic combi boilers can be installed in cabinets but at least 5 cm should be left at both sides.
- If installing in a fitted kitchen at least 30 cm distance should be left under the combi and 5 cm each side for access.
- Do not put electronic devices, corrosive tools, components furniture or equipment below the combi against as there may be a risk of water leakage from the combi safety valve during installation.

2.2.4. Dimensions and Connections

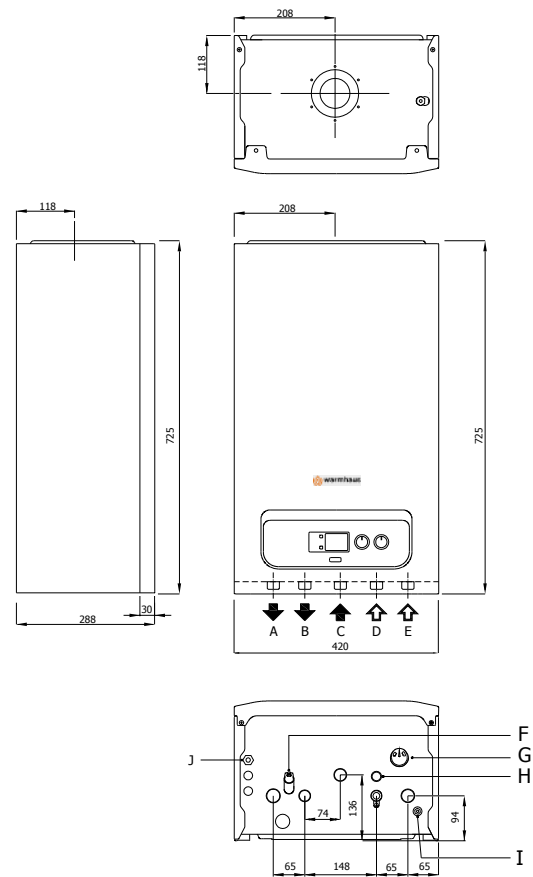

Figure 6 Lawa 18/24 & Lawa Plus 18/24 Combi dimensions connections

Warmhaus Lawa

- A: Central heating flow
- B: Domestic hot water outlet
- C: Gas inlet
- D: Domestic hot water inlet
- E: Central heating return
- F: Filling valve
- G: Manometer
- H: Pressure relief valve outlet
- I: Drain point
- J: 230V 50HZ AC

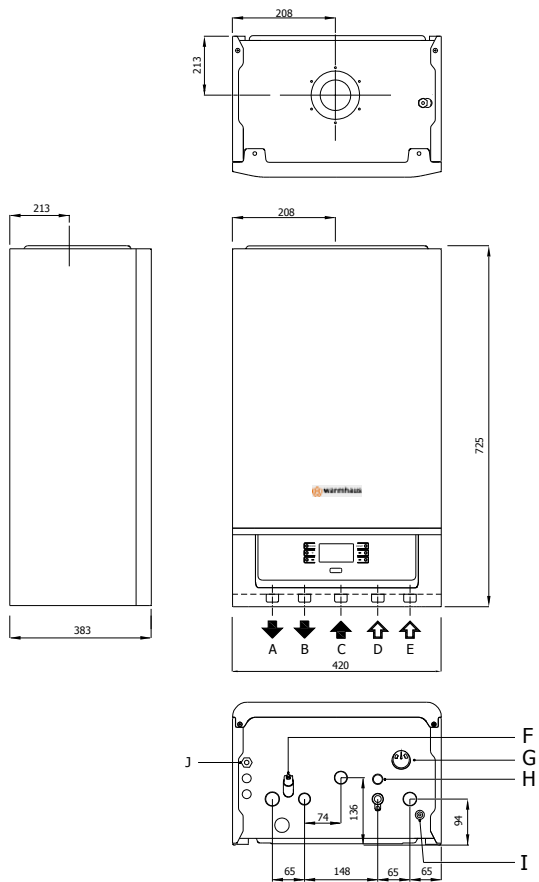

Figure 7 Lawa 28/32 & Lawa Plus 28/32 Combi dimensions and connections

Warmhaus LawaPlus

- A: Central heating flow
- B: Domestic hot water outlet
- C: Gas inlet
- D: Domestic hot water inlet
- E: Central heating return
- F: Filling valve
- G: Manometer
- H: Pressure relief valve outlet
- I: Drain point
- J: 230V 50HZ AC

2.2.5. Natural Gas and LPG Connection (Device Category I2H, I12H3P)

Our combi devices are manufactured to be operated with methane gas (G20) and L.P.G. Gas supply pipes should be equal to or higher than 3/4" G combi connections. Prior to making the gas connection, a thorough internal cleaning should be made to all fuel supply installation pipe furnishings as possible wastes may distort smooth operation and reliability of the combi. Only a mains gas supply can be used with the combi (see the label located on the combi device). In case of any conversions to the supply, changes should only be made to the combi by an authorized professional. Also, in case of reduced pressure, the network dynamic pressure (methane or LPG) used for supplying the combi should be carefully controlled and will impact the combi boiler strength. Ensure that gas valve connection is correct. Flammable gas supply pipe should be able to supply correct adequate gas amount to the boiler when the combi is at full power and be projected and sized according to force and local gas company specification and instructions in order to guarantee the device efficiency. Connection system should comply with gas company legal regulations.

2.2.6. Flammable Gas Quality

The combi is designed to be used with pure fuel not containing any foreign substances; therefore, required filter systems must be available in the gas supply line (for ensuring purification of the fuel).

2.2.7. In Case of Using LPG Tank

LPG use is recommended for heat requirements over 24 kW. New LPG stock tanks may contain settled gas residues (nitrogen) however, that fouds the mixture assigned to that device and may cause abnormal operations. - Various alloy layers may be formed during transit of LPG gas in tanks depending on mixture compositions. That causes a change in heating power of mixture assigned to the device and may compromise efficiency of the device.

2.2.8. In Case of Using Bottled Gas

- 300 mmSS pressurized hood should be used for LPG.
- 500 mmSS hood should not be used.
- 370 mmSS pressurized hood should be used for Propane.
- Do not place tubes in cold places at risk of snow or.
- Do not place tubes in hot places containing ovens or
- Do not make connections with single tubes and use LPG collector set for double, triple uses.
- The distance between the collector and tube should be maximum 125 cm.
- Copper pipe installation should not use for distances longer than 125 cm.
- Hose connection ends should be tightened with clamp and no other tools should be used.
- Gas installation rules with use of LPG tank and industrial tubes should comply with local standards and to be performed by expert installation teams and certified by the company undertaking the construction. In case of failing to fulfil these conditions, combi will not be covered under warrantee by Warmhaus Authorized Services.

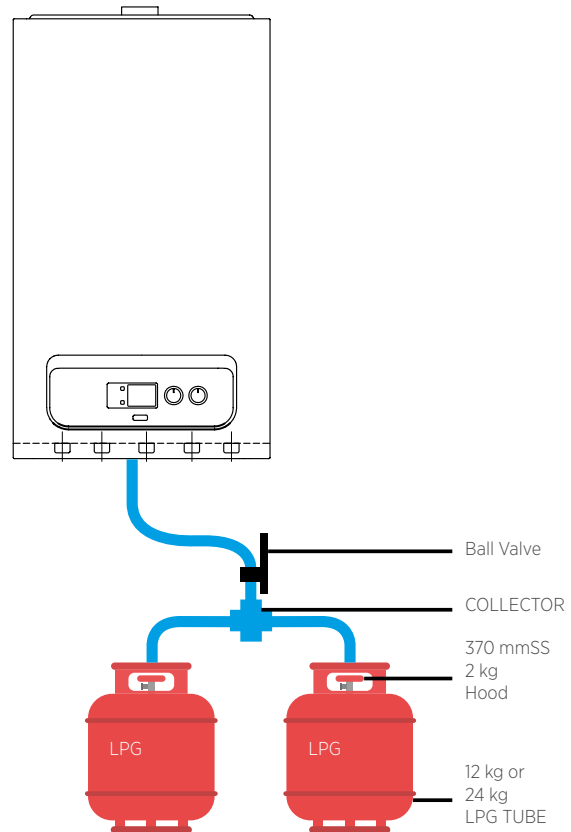

Figure 8 Combi bottled gas connection



2.2.9. Radiator and Domestic Hot Water Installations

Radiator and ground heating installation should be constructed in accordance with technical specifications and heat loss calculation. Radiator type and amount and ground heating installation pipe amount should comply with the heat loss calculation.

- Radiator installation should be designed as resisting to at least 6 bars.
- If the city grid pressure is higher than 6,5 bars, pressure reducer must be installed.
- It is recommended to construct the radiator installation as double line and without using elbow and joints as much as possible.
- Strainer filter must be installed in radiator return and tap water (city grid) input line.
- For example; as the radiator cycle's 8 litres expansion (24 kW) tank can support maximum (80 °C in radiator system) 140 litre and (55. °C in ground heating system) 170 litre installation water expansion, additional expansion tank should be used for larger installation volumes. 170 litre installation water expansion, additional expansion tank should be used for larger installation volumes.
- If the room thermostat and thermostatic radiator valve will be used together; thermostatic valve should not be installed in radiators in the place where room thermostat is available.
- Cross connection must be made for efficient functioning in radiators longer than 1,5 m.
- Covers should be used for radiator and domestic hot water wall passages and fixed with wall clamps to prevent expansions due to heating.
- Combi can function under minimum 0,5 bar domestic hot water pressure and that corresponds to a very low flow rate and therefore, it shall not possible to adjust the requested domestic hot water temperature. For this reason, domestic hot water line should be installed at shortest distance with pipe having at least ½" internal diameter and by using elbows as low as possible. At least 1 bar pressurized grid input water should be supplied to ensure adequate domestic hot water. Hydrophore should be used if required.

- Prior to filling the radiator installation, it must be flushed and all wastes must be cleaned

2.2.10. Exhaust Gas Flue Pipe Set and Accessories Connection

Flue accessory sets to be used in exhaust gas installation of Hermetic combi boilers should be original Warmhaus flue sets and they should be used according to installation instructions.

2.2.11. Peripheral Distances of Flue Output Connections

See Figure 10a for placement of flue set output pipe.

Flue should be installed in accordance with national and local directives. No part of the output pipe or connections should be blocked. If the output pipe passes 1000 mm nearby of a plastic or painted groove or 500 mm of painted fringes, an aluminium shield with at least 1000 mm length should be placed below the groove or fringe. Output pipe should be at least 2 m over surfaces within reach by individuals.

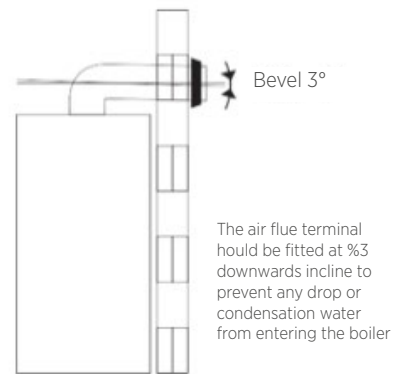
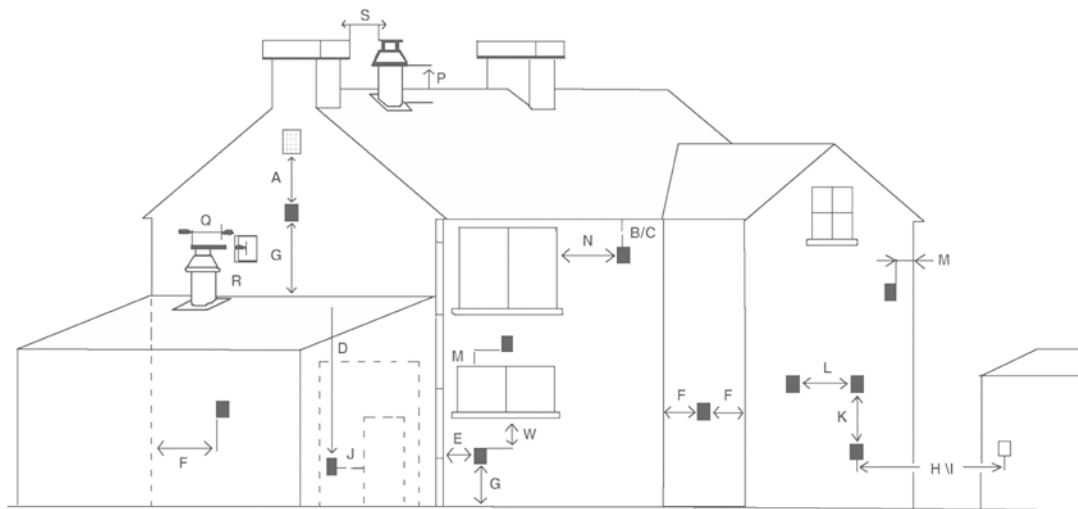

Figure 9 Condensing combi flue slope



Flue Position	Minimum Distance
A Under a window	300 mm.
B Under water groove	75 mm.
C Under fringes	200 mm.
W Under balconies	200 mm.
E To vertical water discharge pipes	150 mm.
F interior or exterior corners	300 mm.
G At ground, roof or balcony level	300 mm.
H On another wall corresponding to the flue	600 mm.
S To another flue To another wall than the garage wall	1200 mm.

Flue Position	Minimum Distance
J To another wall than the garage wall	1200 mm.
R To another flue than the same wall (vertical)	1500 mm.
Q To another flue than the same wall (vertical)	300 mm.
M On another window/culvert On another window /culvert vertically	300 mm.
P On the roof level	300 mm.
I To an adjacent wall	300 mm.
L To the window on adjacent wall	300 mm.
L To another flue	1000 mm.
L	600 mm.

Figure 10 Flue peripheral positions









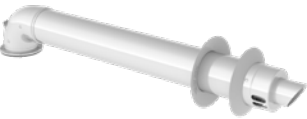

Under certain weather conditions, output pipe may emit water vapour; installation should not be performed at places where this vapour may cause discomfort.
Exhaust gases should be prevented from entering flue ventilation spaces.

Flue system of combi may be installed from inside the room without requiring intervention from the external wall. For that reason, a housing should be installed in the wall for lining the internal surface of channel wherein the output pipe passes through the wall, particularly for thick walls.

2.2.12. Flue Accessories

Concentric (Optional) Flue Accessories (Ø60/100 mm) for Lawa & Lawa Plus Wall-Hung Type Conventional Boilers

The flue accessories (except the Horizontal Flue Set) can be mounted with each other by a tight fit method and therefore no additional parts are required for connection.

Product View	Product Name	Product Code	Explanation
	Ø 60/100 Conventional Horizontal Flue Set	150.11.014.000001	Horizontal Flue Set with Flue Clamp Bracket can be used till 5 m with Stretching Flue Accessories.
	Ø 60/100 Conventional Horizontal Flue Set For Frost Protection	153.11.660.600004	Horizontal Flue Set with Flue Clamp Bracket for Frost Protection can be used till 5 m with Stretching Flue Accessories.
	Ø 60/100 Conventional Vertical Flue Set With Adapter	153.11.660.600010	Vertical Flue Set can be used with Extension Flue Accessories up to 6 m. For usage of vertical flue set Ø60/100 Conventional Condensed Vertical Adapter with Flange (Product code:153.11.660.600011) must be installed to boiler flue output.
	Ø 60/100 Conventional Flue Extension L = 500 mm	153.11.660.600005	It can be used with Horizontal Flue Set and Vertical Set.
	Ø 60/100 Conventional Flue Extension L = 1000 Mm	153.11.660.600006	
	Ø 60/100 Conventional Flue Extension L = 2000 Mm	153.11.660.600007	
	Ø 60/100 Conv. Concentric 45° Elbow	153.11.660.600008	It can be used in horizontal and / or vertical flue applications. Each 45° elbow usage requires to decrease maximum 50 cm from horizontal/ vertical distance.
	Ø 60/100 Conventional 90° Elbow	153.11.660.600009	It can be used in horizontal and / or vertical flue applications. Each 90° elbow usage requires to decrease maximum 100 cm from horizontal/ vertical distance.
	Ø 60/100 Conventional Condensed Vertical Adapter	153.11.660.600011	It is the accessory which must be installed to boiler flue output if Vertical Flue Set is used.



2.2.13. Installation with Horizontal Flue Sets (Ø60/100 mm)

Connecting Horizontal Hermetic Flue Set to the Combi

Since your combi is a hermetic model, it takes the used air from outside and discharges exhaust gases created as the result of burning through the same flue group. In order to prevent emission of excessively harmful exhaust gases, flue usage and installation is very important, therefore warnings should be taken into consideration when flue connections are being performed.

- Make required flue selection for the external flue connection. If the standard flue set is not adequate, please select most suitable elements from our list of connection accessories considering warnings given in our user guide.
- Fix the flange under the elbow piece (1) by using the Flange Bolt (5) via Flange Connection Screws (4) to holes on the combi.
- 2 x Ø60 Sealing Gasket (6) are placed into internal pipe slots at both ends of the 90° elbow.
- Place the Ø100 Sealing Gasket (12) on the 90° elbow contacting with the restrictive set.
- Place the External Wall Plate into the flue terminal as seen in Figure

11-12. for grouping the flue output terminal. After placing the flue output terminal through exterior of wall and the previously made hole, fix the Internal Wall Plate (11) into the flue terminal. Place, 90° flue elbow of your combi coupled tightly to the flue output terminal (Figure 12). Then fit the outer and inner wall flanges (Fig.11_11-12) on the terminal pipe (Fig.12). Finally, push the Internal Wall Plate to the wall surface and ensure flue and wall impermeability.

In case the hermetic flue set available in the product package does not have adequate length, hermetic flue accessories should be ordered from an authorized Warmhaus dealer according to requirements, non-original hermetic flue accessories should never be used.

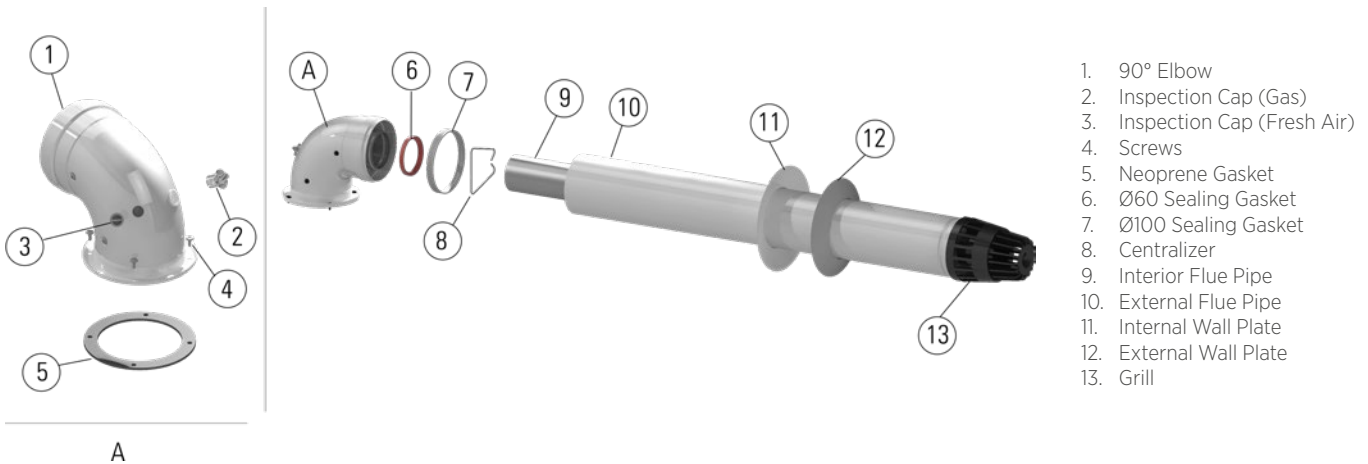

Figure 11 Hermetic combi homocentric flue set.

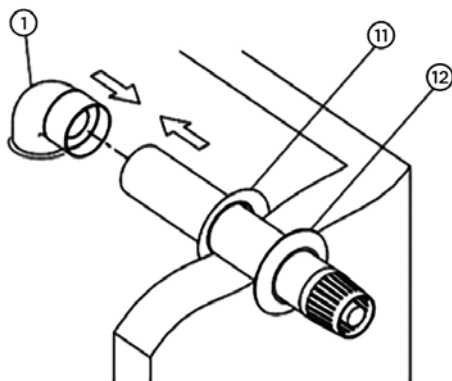

Figure 12 Hermetic combi homocentric flue wall output

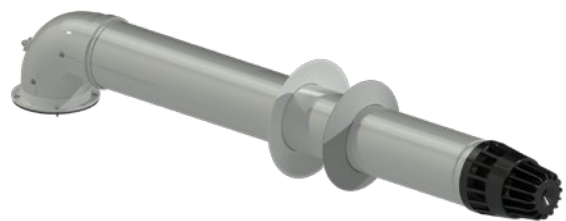

Figure 13 Assembled Flue Set



Connecting Horizontal Hermetic Flue Set to the Combi

Since your combi is a hermetic model, it takes the used air from outside and discharges

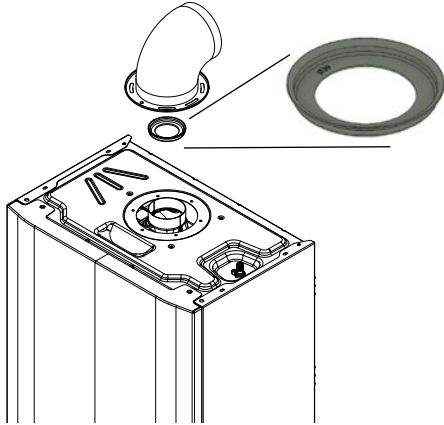

Figure 14 Installation of reduction stamp

Pipe Lengths (m) Reduction	Exhaust Gas Relief
$0 \leq L \leq 1$	Place the reduction
$1 < L \leq 5$	No reduction stamp

Total length of hermetic flue set should not exceed 5 m with single elbow horizontally. Also, this total length reduces by 1 m with every 90° elbows or two 45° elbows. Maximum 3 pieces of 90° elbow can be used.

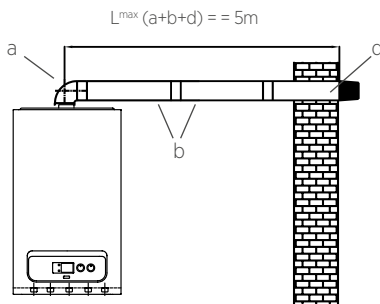

Figure 15 I. Single 90° bended sample flue installation

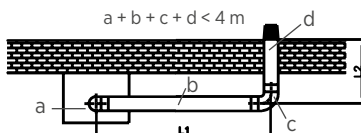

Figure 16 II. Two 90° elbow sample flue installations

- a- Standard Flue Set Elbow (90°)
- b- Flue Extension Pipe
- c- Additional 90° Elbow
- d- Standard Flue Set Pipe

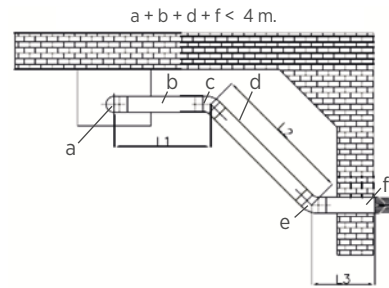

Figure 17 III. Single 90° and two 45° elbow sample flue installations

- a- Standard Flue Set Elbow (90°)
- b- Flue Extension Pipe
- c- Additional 45° Elbow
- d- Standard Flue Set Pipe
- e- Additional 45° Elbow
- f- Standard Flue Set Pipe

2.2.14. Installation with Horizontal Flue Sets

Your combi can also be vertically connected to flat and sloping roofs via available connection accessories depending on the status of installation place. For flat connections, 5 meters height is acquired with (Ø 60/100 mm) vertical flue set and, 6 meters with (Ø 60/100 mm) vertical flue set.

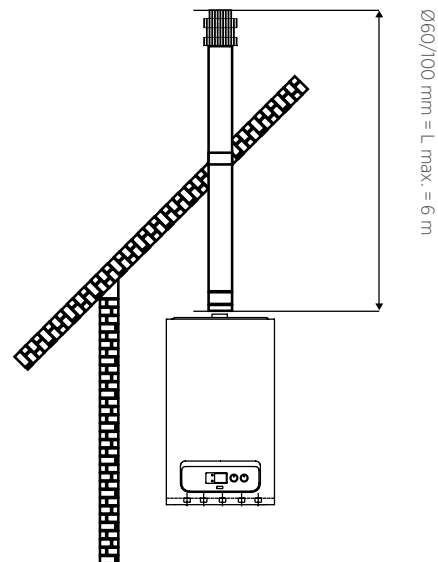
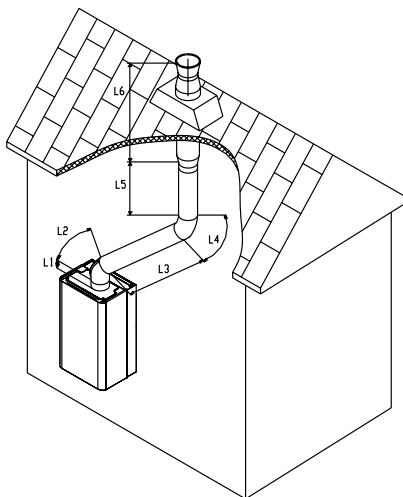

Figure 18 Vertical flue set installation



Figure 19 Condensed Vertical Adapter and vertical flue set installation detail



Implementation

- L1** = 0.3 m.
- L2** = 0.5 m. (45° elbow equivalent length)
- L3** = 1.0 m.
- L4** = 0.5 m. (45° elbow equivalent length)
- L5** = 0.5 m.
- L6** = 0.5 m.

L Total = 3.3 m. 3.3 m. < Lmax = 6 m.

Correct in implementation

Figure 20 Hermetic and vertical flue set installation application

2.2.15. Installation at Partially Protected Exteriors

Installation Instructions: This combi can be installed in partially protected exteriors but not fitted in places at risk of atmospheric damage – and protected against poor weather.(rain, snow, etc.).

Frost protection: Combi device is equipped with a system that prevents frost by automatically activating the pump and boiler when the internal water is lower than 5°C.

Frost protection function only depends on below given conditions:

- If the combi is correctly connected to gas and electrical sources;
- If the combi is supplied from gas and electricity sources in a fixed way;
- If the Combi is not in failure situation due to lack of ignition;
- If radiator installation pressure is full and radiator valves are open;
- Provided main components are not damaged, the combi is protected against frost up to -5°C environment temperature.

Lowest Temperature -5°C. In case the combi is installed in an environment with a temperature lower than -5°C, and gas supply is interrupted or passed into failure due to failing to make ignition, Frost Prevention System shall not be activated and frost/failure shall occur in the device. Following instructions should be followed for preventing the risk of frost:

- Heating circuit; anti freeze may be used with caution according to manufacturer's instructions.

In case of having flammable walls or passages in environments with Hermetic Flue Type, fire resistant insulation material is placed between the wall and exhaust gas relief pipe.



Materials used for manufacturing the combi are resistant against glycol and propylene based anti-frost liquids. Follow warnings by supplier company instructions for safe disposal.

- If the combi is correctly connected to the electrical source;
- If the main switch is on;

Under these conditions, the combi is protected against frost up to -5°C temperature.

Frost protection of the combi boiler is guaranteed only under these conditions:

Damages arising from interruption of electrical power and not following issues mentioned in previous pages regarding efficiency of Warranty.

Note: In case the combi device is installed at places with temperature lower than 0°C (both for domestic hot water ad radiator purposes) both radiator installation and tap water pipes must be insulated.

2.2.16. Electrical Connections

Ensure electrical safety of combi by connecting to an effective earthing installation that follows safety instructions in force. It is dangerous and unacceptable to use gas and water connection pipes for earthing.

WARNING! WARMHAUS A.Ş. cannot be held responsible for any damage or loss to individuals or property arising from failing to provide earth connection of the combi and not being fitted by a competent electrician or registered individual in accordance with directives and standards in force in the country where the boiler is fitted.

Also, ensure that the electricity installation complies with the maximum power to be supplied as indicated in technical specifications label Combi is supplied with "X" type socketless special power supply cables.

"Warmhaus combi has an IPX5D protection level. Power supply cable should be connected to 230 V +%10; -%15 50Hz grid with L-N poles and relying on the earth connection, high voltage category 3rd class multiple poled disconnected should be envisaged on the same grid. Your device



is designed as enabling normal functioning between min 195V and max 255V in accordance with standards. If this range is not maintained in your electricity grid, (195-255V) it is recommended to use voltage regulator. Contact our Authorized Warmhaus Service for replacement of the cable.

Power supply cable should follow the defined route. If the adjustment card is replaced, please use 2A or 3,15A speed type fuses. from the general electricity grid, adapter, multiple sockets and extension cables are not allowed to use.

2.2.17. Optional Controls: Room Thermostat, External Weather Temperature Sensor and Others

Room thermostat, Outside Temperature Sensor, etc. control devices must be connected to Warmhaus combi devices by the authorized service personnel; in case connections are performed by unauthorized persons, combi warranty shall be void.

Please follow user's instructions for placement of Outside temperature Sensor.

This sensor can be directly connected to electrical installation of the combi, and it automatically reduces the maximum return water temperature in the installation when exterior weather temperature rises for enabling functioning according to outside temperature changes sent to radiator installation. Outside Temperature Sensor is activated when connected as independent from the used room thermostat typology and functions as common with room thermostats. The relation between installation input temperature and exterior weather temperature is defined according to curves in the diagram from position of the button located on the panel of combi (or on the control panel if connected to combi (Figure 33).

Electrical connection of Outside temperature Sensor should be made to combi electronic card to the connectors that white cables (Figure 21).

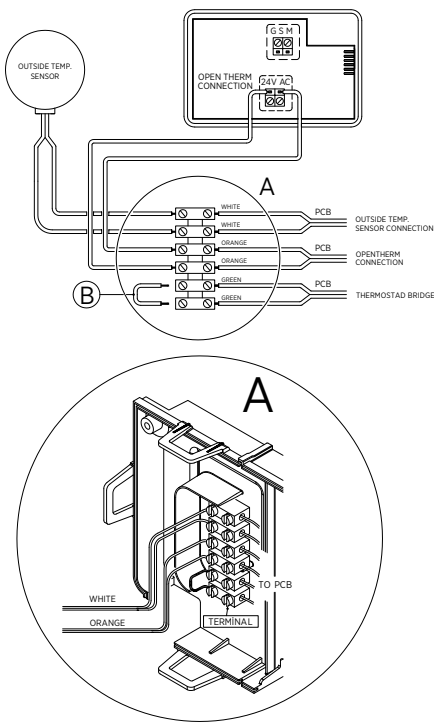

WARNING: Remove the bridge wire from the room thermostat/timer terminal (B) when the timer or OpenTherm connected the boiler!

Figure 21 Combi room thermostat and Outside Sensor connections.

COMBI CONTROL ACCESSORIES



WT-RF03 Large Screen, Modulated, Weekly Program Scheduled, Wireless room thermostat
Product Code: 153.11.660.600022



WT-08 Large Screen, Modulated, Weekly Program Scheduled, Cable room thermostat
Product Code: 153.11.660.600021

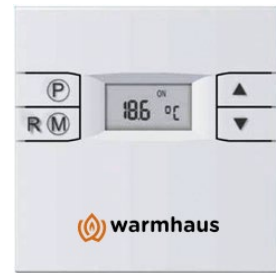

WT-07 Modulated, Weekly Program Scheduled, Cable room thermostat
Product Code: 153.11.660.600020



WDHS-01 Outside Sensor
Product Code: 153.11.660.600001



2.3. HYDRAULIC INSTALLATION RULES

2.3.1. Radiator (Heating) Water Structure



Warning: In order to prevent invalidity of device warranty prior to making combi connections, clean possible residues found in main heat exchangers (pipes, heater assembly, etc.) with dissolvent or equal substances, otherwise they will negatively affect functioning of the combi. In order to prevent limescale in the radiator follow rules envisaged by standards regarding domestic hot water and radiator installations.



Warning: It is recommended to install a Anti-Lime Kit for preventing occurrence of limescale at places where water hardness is higher than 25 French degree in order to protect service life and efficiency of the hot water tap heat exchanger.

2.3.2. Filling/Emptying Radiator Installation

Ensure that the pressure reaches to 1-1,5 bar in the Manometer indicated with M symbol by rotating the Filling Tap indicated with F symbol in the Lower View image in Page 6-7 for filling the closed circuit radiator installation after installation of the combi and close the Filling Tap by rotating clockwise and re-discharge the air with air relief valves of the radiator.

Combi safety valve relief should be connected to a discharge cone. Otherwise, safety valve shall be activated and manufacturer shall not be responsible due to water discharge around the device.

2.3.3. Circulation Pump

As the combi is equipped with a pump having 3 speed levels, pump level should be selected according to critical line pressure loss and required flow rate should be maintained according to this pressure.

2.3.4. Controls for Initial Operation of Combi

In order to prevent void warranty scope, initial startup of the combi must be performed by the Warmhaus Authorized Service. Below given initial preparations should be performed prior to authorized service appointment request:

- Gas opening approval certificate should be taken from the local gas company for your gas line,
- Combi electricity connection should be made via 2 or 3 Amps fuse.
- Ensure the home has an uninterrupted water and gas supply.
- Ensure that water is supplied to radiator installation and 1,2 - 1,5 bar pressure is seen in the combi manometer.

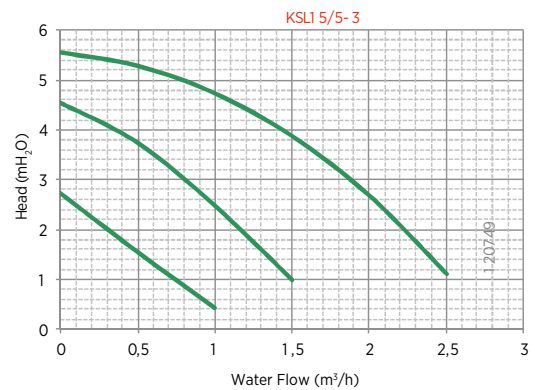
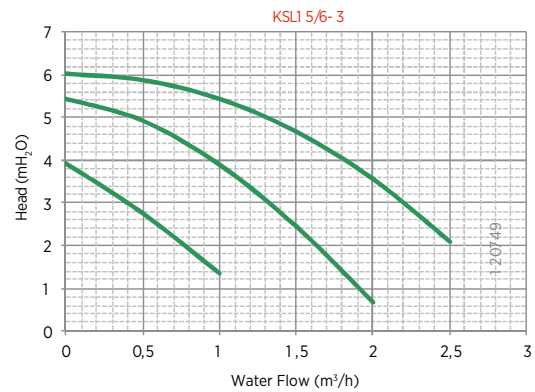

Figure 22 Pump Flow Rate / Pressure Graphic



Figure 23 Pump with automatic air relief cock and 3 speed levels.

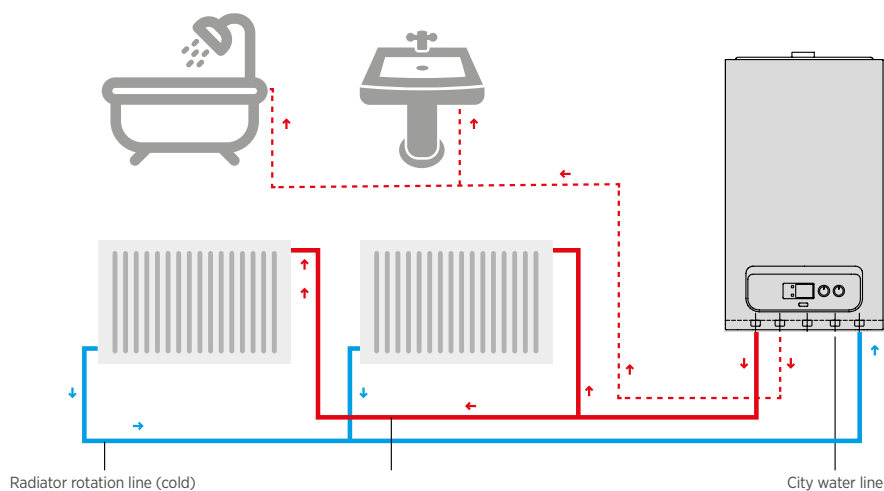
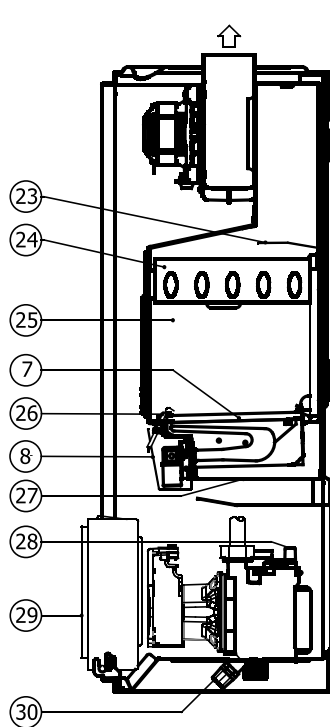
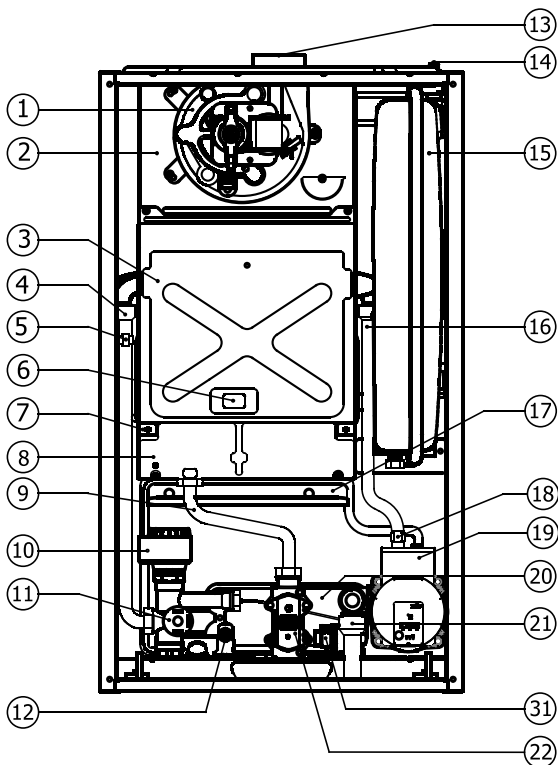

Figure 24 Combi general installation scheme

Note: Connection Group (optional)



2.4. BOILER COMPONENTS



1. Fan
2. Hood Fume
3. Burning Chamber
4. Radiator (CH) Output Pipe
5. Safety Thermostat
6. Observation Glass
7. Boiler
8. Heat Reflector
9. Gas Inlet Pipe
10. 3 way motorized valve
11. Low Water Pressure Switch
12. Domestic Hot. Water Output Sensor
13. Fan Flue Output End
14. Expansion Tank valve
15. Expansion Tank
16. Radiator (CH) Return Pipe
17. Lower Heat Reflector
18. Expansion Tank Connection Pipe
19. Pump
20. Exchanger with Plate
21. 3 Bars Safety Valve
22. Gas Valve
23. Deflector Plate
24. Main Exchanger
25. Burning Chamber Insulation
26. Ignition and Ionization Electrode
27. Diffuser Plate
28. Automatic Air Relief Cock
29. Control Panel
30. Filling Tap

Figure 25 Components of Combi

3. USER SECTION

3.1. GENERAL WARNINGS FOR USER

3.1.1. Use of Combi

 If a gas odour is present, close home entrance line and gas valves of your combi or close the LPG tank valve or tube valve if bulk gas is used. Do not switch electricity buttons and do not do anything those may create sparks. Call the gas company or Authorized Service. (See 1.3 GAS LEAKAGES, Page 6)

First start should be performed by the Warmhaus Authorized Service for your safety and preventing void warranty scope. Our Authorized Service will give you required information about use of combi after performing initial controls of your combi and starting for the first time.

Perform below given controls prior to starting to use:

- Ensure that radiator/heating system, tap water and gas valves located under your combi are open, the radiator installation pressure is between 1 - 1,5 bar on the manometer located under the Combi and system air is discharged,
- Gas is available in your gas line (you can control by igniting one of your gas ovens),
- Combi electrical fuse is open,
- No flammable materials and products are available near to the Combi,
- Ensure exhaust gas flue set output is not blocked,
- If a room thermostat or control device is connected, ensure that it is in the ON position.

If you shut-off the combi for a long period, perform below written operations:

- Discharge the radiator installation water not containing anti-freeze,
 - Close combi electrical fuse, gas valve, radiator and tap water valves!
- If you will shut-off the combi for a short period, perform below written operations:
- Do not close combi electrical fuse, gas valve, radiator and tap water valves!
 - Leave the Combi at Summer position and activate its Frost Protection function,

Shut-off the combi during maintenance and repair operations to be performed around exhaust gas discharge flues. After operations are completed, have the combi controlled by Warmhaus Authorized Service prior to starting the combi.

Follow below given main rules:

- Do not clean external frame of combi while combi is functioning and do not use flammable materials.
- Do not touch the combi with wet hands or feet; also without shoes and with bare feet.
- Do not unpick electricity cables.
- In case cables are damaged, shut-off the combi and fuse switches and do not use the combi.
- Electrical cables of combi and it's accessories should only be replaced by the Authorized Service.



LAWA COMBI CONTROL PANEL



Figure 26 Lawa combi boiler control panel

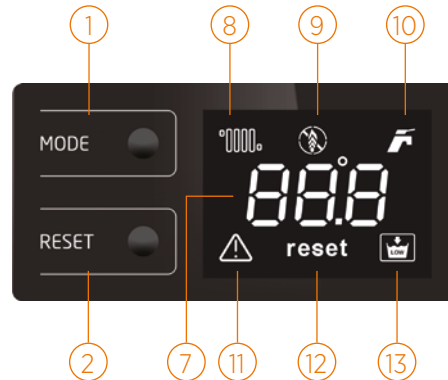

Figure 27 Lawa combi boiler control panel screen



BUTTONS AND PUSHBUTTONS

1. MODE, position adjustment button.
2. RESET button.
3. Radiator (CH) water temperature adjustment button.
4. DHW temperature adjustment button.
5. Software connection slot.
6. Digital display screen
7. Temperature, data and failure codes display
8. Radiator symbol is seen when combi is functioning in (CH) position. Symbol flashes at heating steps or when radiator temperature adjustment is made.
9. Flame symbol is only seen when boiler is active (burning in combi); when system detects availability of flame. It is seen as symbol in case of failure.
10. DHW tap symbol is seen at summer and/or winter position of the combi. Symbol flashes on DHW request or when DHW adjustment is made.
11. Failure indicator.
12. Failure status RESET requirement.
13. Radiator low water pressure.

The temperature value displayed on the combi screen has a $\pm 3^{\circ}\text{C}$ tolerance depending on environmental conditions not arising from the combi.

LAWA combi screens consist of navy blue colored backlight LCD screen, 2 buttons, Radiator (3) and Hot Tap Water (4) and 2 pcs, RESET (2) and MODE (1) pushbuttons.

RESET: It is used for re-starting the combi and eliminating the failure in case of combi failure.

MODE: Winter/Summer/OFF mode is used for position adjustment.

Operating positions and related notifications:

POSITION EXPLANATIONS:

- CLOSED or OFF (3 digits LCD screen)
- WINTER► Radiator temperature + °C + tap + radiator is displayed.
- SUMMER► Radiator temperature + °C + tap is displayed.
- CH ON► Radiator Temperature + °C + tap + flashing radiator (symbol) is displayed.
- DHW ON► DHW temperature + °C + flashing tap (symbol) is displayed.
- CH FROST PROTECTION► Radiator temperature + °C + flashing radiator (symbol) + when boiler is ignited flame (symbol) is displayed.
- DHW FROST PROTECTION► CH temperature + °C flashing radiator and tap (symbol) + when boiler ignited flame (symbol)
- CH/DHW SETTING CHANGE► CH adjustment change will be activated when radiator symbol rapidly flashes. DHW adjustment change will be activated when tap symbol rapidly flashes.
- Service technician function radiator + tap displayed. (Only for authorized service, wait for the function to end without pressing any button or rotating the button in such case!)

CH: (System) Central Heating DHW: Domestic Hot Water



3.2. SELECTION OF ON/OFF/STANDBY AND SUMMER/WINTER MODES

Use V automat switch for interrupting the electrical connection of combi. The temperature value when electricity is supplied to the device is the temperature value of water in the installation.

3.2.1. On/Off/Standby Positions

Use V automat (fuse) switch for shutting ON/OFF the electrical connection of combi.



When the combi is started for the first time, screen displays nG letter and then a number (for instance 24) indicating kW power of the device.



Then, OFF letter is displayed,



and screen light is closed. Now, combi is in STANDBY position. The temperature value when electricity is supplied to the device is the temperature value of water in the installation.

3.2.2. Operation at Winter Position

At that position, combi operates both for heating the environment and providing hot tap water.



Radiator temperature is adjusted with button (3) and Domestic Hot Water temperature adjustment is made with button(4) and this temperature is displayed by indicator (7) on the screen.



In order to shuton the combi, hold **MODE** button, whereas a circle starts on the screen, release the button when circle is completed.

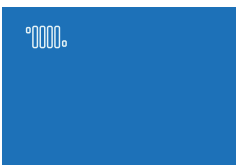

In such cases, combi initially gets in the Radiator position, it's symbol flashes at left top corner of screen and existing radiator installation temperature is displayed on the screen and then screen light turns off. At that position, you can adjust the temperature between 35 – 80 °C with the Radiator (CH) temperature adjustment button (3).

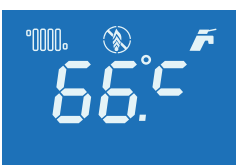

Temperature value increases when button is rotated clockwise or decreases when rotated counter clockwise. The adjusted value shall be confirmed after flashing for 4-5 seconds after releasing the button and continues to display the temperature value in the installation.



{If you have a ground heating system adjust your combi for “Low Temperature Operation”, maximum temperature shall be limited with the Radiator temperature adjustment button (3) (e.g. maximum 50 °C)}.



At that position, you can adjust the temperature between 35 – 60 °C with the domestic hot water temperature adjustment button (4) whose symbol is displayed. When DHW button is rotated, while screen light is on if you rotate (right) clockwise, you can increase the temperature, and you can decrease the temperature when rotated counter clockwise (left).

3.2.3. Operation at Summer Position

Combi only operates for heating the domestic hot water at that position. In order to switch to DHW position;



If you are starting the combi for the first time hold **MODE** button, and release the button after the cycle is completed on the screen, initially combi switches to radiator position, it's symbol will flash on left top corner of the screen existing radiator installation temperature shall be indicated on the screen and screen light will be turned-off.



In order to switch to DHW position, hold **MODE** button and release the button after completion of cycle on the screen. At that position, symbol flashes at right top corner of the screen and existing DHW temperature will be seen on the screen and screen light will turn off.

3.2.4. Resetting the Combi (Re-Starting)

In cases that device gives failure/locking errors hold **RESET** button for 3-4 seconds, and release after completing the cycle on the screen. You can reset the device and re-start operations.

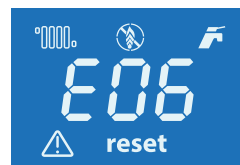

A sample utilization error; when E81 or E06 failure codes are displayed on the device screen, it has passed to failure since no ignition occurred in your device. In that case, any of gas line valves connected to the combi may be closed, combi boiler will be restarted when closed valve is opened and **RESET** button is pressed. If combi is not started with resetting, please consult our Authorized Service.

3.2.5. Shutting OFF the Combi

To bring the combi to OFF position while it is in SUMMER position;



When the **MODE** button is hold, after the cycle is completed while screen light is on,



Screen will display OFF letter, that means your combi is OFF.



To bring combi in OFF position while it is in WINTER; hold MODE button, after cycle is completed while the screen light is on, combi will be in SUMMER position.



Then, upon repeating the same operation, letter will be displayed on screen after completing the cycle and screen light turns off.



Now, your combi is at STANDBY position as OFF.

LAWA PLUS COMBI BOILER CONTROL PANEL



Figure 28 Lawa Plus combi control panel

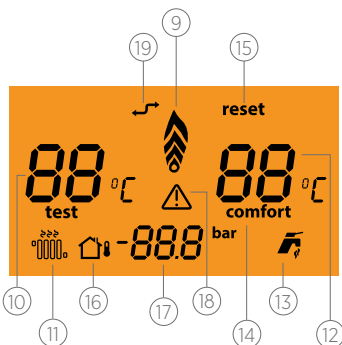

Figure 29 Lawa Plus combi control panel screen

BUTTONS AND PUSHBUTTONS

1. MODE, position adjustment button.
2. RESET button.
3. Radiator (CH) temperature increasing button.
4. Radiator (CH) temperature decreasing button.
5. Software connection slot.
6. Digital display screen
7. Domestic Hot Water temperature increasing button.
8. Domestic Hot Water temperature decreasing button.
9. Flame modulation indicator
10. Radiator (CH) water temperature
11. Radiator (CH) mode operating indicator
12. Domestic Hot Water temperature
13. Domestic Hot Water operating indicator
14. Comfort mode operation
15. Failure status RESET requirement.
16. External Weather Temperature Sensor connection indicator
17. Digital manometer (Radiator pressure 1,3 bar warning symbol; E02 failure code is indicated if the pressure is lower than this value)
18. Failure indicator.

The temperature value displayed on the combi screen has a $\pm 3^{\circ}\text{C}$ tolerance depending on environmental conditions not arising from the combi. Screen of Lawa Plus combi models consist of amber colored backlight LCD screen 6 pieces: RESET, MODE, CH (+), CH (-), DHW (+), DHW (-) pushbuttons.

RESET: It is used for re-starting the combi and eliminating the failure in case of combi failure.

MODE: Used for Winter/Summer/OFF mode adjustment.



Operating positions and related notifications:

POSITION EXPLANATIONS:

- Service technician function radiator + tap displayed. (Only for authorized service, wait for the function to end without pressing any button in such case!)
- CLOSED or OFF (3 digits LCD screen)
- WINTER► Radiator temperature + °C + tap + radiator is displayed.
- SUMMER► Radiator temperature + °C + tap is displayed.
- CH ON► Radiator Temperature + °C + tap + flashing radiator (symbol) is displayed.
- DHW ON► DHW temperature + °C + flashing tap (symbol) is displayed.
- CH FROST PROTECTION► Radiator temperature + °C + flashing radiator (symbol) + when boiler is ignited flame (symbol) is displayed.
- DHW FROST PROTECTION► CH temperature + °C flashing radiator and tap (symbol) + when boiler ignited flame (symbol)
- CH/DHW SETTING CHANGE► CH adjustment change will be activated when radiator symbol rapidly flashes. DHW adjustment change will be activated when tap symbol rapidly flashes.
- Service technician function radiator + tap displayed. (Only for authorized service, wait for the function to end without pressing any button in such case!)



3.2.6. Selection of On/Off/Standby and Summer/Winter Modes

ON/OFF button is not available on the combi panel. Switching on/off should be performed on the V automat switch connected to the combi line.

3.2.7. On/Off/Standby Positions

ON/OFF button is not available on the combi panel. Switching on/off should be performed on the V automat switch to be connected to the combi line.

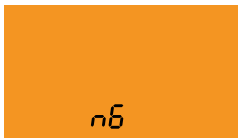

When the combi is started for the first time, screen displays nG letter and then a number (for instance 24) indicating kW power of the device.



Then, OFF letter is displayed,



and screen light is closed. Now, combi is at STANDBY position. The temperature value when electricity is supplied to the device is the temperature value of water in the installation.

3.2.8. Operation at Winter Position

At that position, combi operates both for heating the environment and providing hot tap water. Radiator temperature adjustment is made with (3) and (4) numbered buttons in Figure 28, Domestic Hot Water temperature adjustment is made with (7) and (8) numbered buttons and this temperature is indicated with (10) numbered indicator for Radiator and with (12) numbered indicator for Domestic Hot water.



Hold the MODE button for switching on the combi when letter is available on the screen.



A cycle starts on the screen.

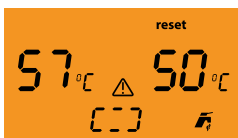

Release the button when cycle is completed.



In some cases, combi initially gets into Radiator position, its symbol flashes on the left bottom corner of screen and tap symbol is seen at right bottom corner. A digital manometer indicating the installation pressure is located on the lower middle section of the screen and also existing radiator installation temperature is seen on the screen at the same time and screen light is turned off.



Analogue manometer is located near to right-bottom side of the combi. Installation pressure should be seen in this manometer even in the absence of electricity.

When combi is started, flame modulation symbol is seen at the middle section of the screen. At that position, you can increase and decrease the temperature with radiator temperature adjustment buttons (see. Figure 28) (3) between 35 – 80 °C, screen lights when buttons are pressed and °C symbol flashes besides the radiator temperature value.



{If you have a ground heating system, as our Authorized Service adjust your combi for "Low Temperature Operation", maximum temperature shall be limited with the Radiator temperature adjustment button (3) (e.g. maximum 50 °C)}.

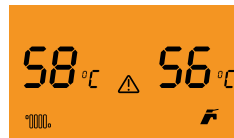

Domestic Hot Water Adjustment at Winter Position; You can adjust the hot tap water temperature value between 35 – 60 °C with (7) and (8) numbered buttons under the RESET button. Screen lights during temperature change, DHW symbol flashes besides the DHW temperature value. Screen light turns off after adjustment.

3.2.9. Operation at Summer Position

Combi only operates for heating the domestic hot water at that position. In order to switch to domestic hot water position;



If you are starting the combi for the first time hold MODE button, and release the button after the cycle is completed on the screen, initially combi switches to radiator position, its symbol will flash on left top corner of the screen existing radiator installation temperature and screen light will turn off.

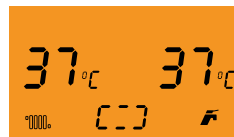

In order to switch to tap water position, hold MODE button and release the button after completion of cycle on the screen. At that position, symbol flashes at right bottom corner of the screen and existing domestic hot water temperature will be seen on the screen and screen light will turn off.



At that position, you can adjust the hot tap water temperature between 35 – 60 °C with (7) and (8) numbered buttons below the RESET button.

Screen lights during temperature change, DHW symbol flashes besides the DHW temperature value. Adjustment value is confirmed after screen light turned off following the adjustment.



3.2.10. Shutting Off the Combi

To bring the combi to OFF position while it is in SUMMER position;

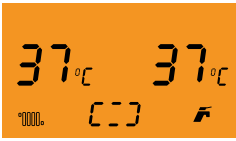

When the MODE button is hold, while screen light is on after the cycle is completed, letter seen on the screen, screen light turns off, now the combi is at OFF position.



To bring the combi to OFF position while it is in WINTER position;

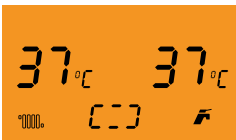

When the MODE button is hold while screen light is on after the cycle is completed, combi shall pass to SUMMER position.

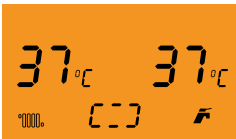

Then, when the same transaction is repeated, after cycle is completed a letter is seen as the screen screen light turns off, your combi is now at STANDBY position.

3.2.11. Use with Room Thermostat (Optional)

To bring the combi to OFF position while it is in SUMMER position;



Important: It is compulsory to have two different lines according to legal regulations being in force regarding electrical installations in case of using a thermostat On/Off on the Remote Control. It is not allowed to use any pipe or hose of the combi as electricity or phone earthing line. That must be ensured prior to making electrical connections of the combi.

General Utilization Type

- Please consult our authorized services for room thermostats compatible with Warmhaus combi.
- Do not remove device components during operation.
- Do not position in direct sunlight exposure or near heat sources.
- Manufacturer company shall not be responsible for below given situations:
 - a) Faulty installation
 - b) Making intervention on the device by unauthorized persons

Installation Instruction: Device installation shall only be performed by the Warmhaus Authorized Service. The dual cable required for installation is supplied by the dealer/consumer.

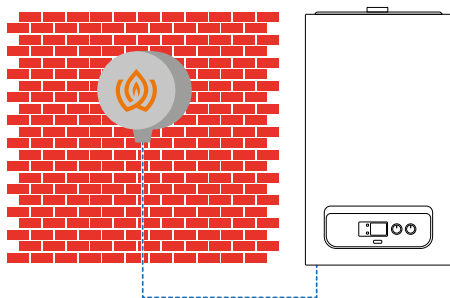

Figure 32 Outside weather temperature sensor



Room thermostat should be installed at 1,25 and 1,50 m height from ground and at least 30 cm distance.



At least 30 cm distance should be available from doors and windows open for air circulation.

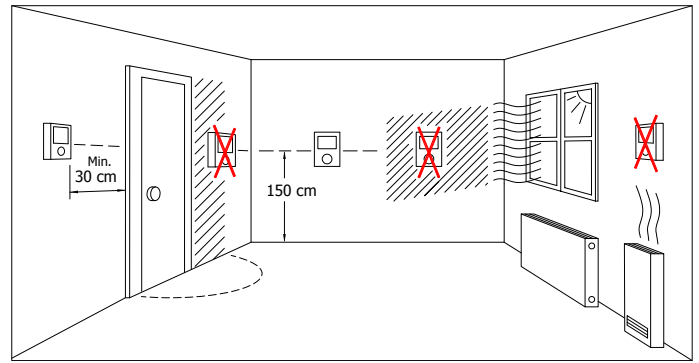

Figure 31 Thermostat position

Maintenance and Service Life: Warmhaus room thermostat should not come into contact with water or excessive humidity. Unless an external damage

3.2.12. Outside Temperature Sensor Use (Optional)

Outside Temperature Sensor (optional) can be installed in your combi by our Authorized Service (see: Installation Section; Accessory Connection Scheme), and you can enable automatic temperature adjustment for the radiator with immediate responses to outside weather temperature changes via smart and comfort operation (Figure 32). Therefore, it maintains an efficient and economic operation by reducing the radiator water temperature when outside weather temperature increases and gradually increasing the radiator water temperature when outside weather temperature decreases and sets you free from making radiator temperature adjustments. This sensor is activated when connected independently from the typology or availability of used thermostat, the relation between output temperature and outside temperature is defined according to curves given in the graphic below based on position of button located on the combi panel.

After connecting the Outside Temperature Sensor, (Figure 32) adjustment is made according to average external weather temperature of your province with P04 parameter. Our authorized service will make this adjustment during installation (Figure 33).

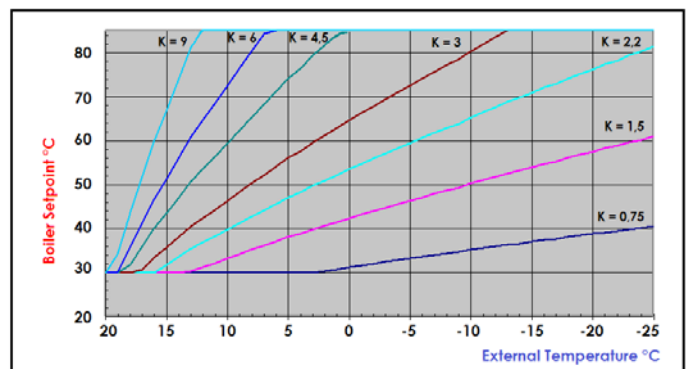

Figure 33 Outside temperature sensor operation curves



3.2.13. Customizing Combi Features

As your combi has an advanced electronic card, operation conditions and certain parameters related with your preferences may be changed by our Authorized Service. Please consult our authorized service when any changes requested in below given parameters.

(P06) (CH) (Heating) Power.

Combi is equipped with an electronic modulation with power suitable with actual heat requirement of installation place. Thus, the combi automatically operates with variable gas flow rates depending on heat load of installation between the minimum and maximum power.

(P07) Controlled Power Increase Period.

When combi starts, it uses a controlled period defined for reaching the adjusted maximum heating power. This period is adjusted as 3 minutes as standard and can be increased up to 3 minutes.

(P21) Low temperature region selection.

This parameter should be adjusted as 1 for ground heating or heating systems operating with low temperature. 0 (zero) value is selected for radiator systems to operate at high temperatures as standard.

(P24) Child Protection

Your combi is protected against setting changes with the child lock that is activated when the MODE button is pressed for 5 seconds. Protection lock is activated when the parameter is adjusted as 1.

(P40) Radiator ignition delay period.

Combi device is equipped with an electronic timer for preventing frequent ignition by the combi during heating stage. This period is adjusted as 2 minutes as standard and can be increased up to 10 minutes.

(P42) Ready Hot Water (Pre-Heating passive/active).

In order to rapidly prepare the domestic hot water without your request and reducing the cold water consumption during waiting, it heats the grid water in plate exchanger and keeps as hot water. This function can be activated in 6 buttons LAWAPLUS models. Pre-heating function is activated when domestic hot water temperature increase Figure 28 (2) RESET button is pressed until cycle is completed. At the end of this period, Pre-On (active), Pre-Off (passive) is seen on the LCD screen for 5 seconds.

Activation of this function in LAWA models is enabled with parametric adjustment by our Authorized Service according to your request.



Air Discharge Function

Activating the menu for LAWA, PRIWA and ENERWA models: Air discharge function can be activated by pressing the RESET button more than 5 seconds while CH button and DHW button are at maximum position. Upon activation of this function, 3 way valve and pump is operated or not operated for discharging the air within the radiator installation.

4. TROUBLESHOOTING

4.1. FAILURE CODES TABLE

Failure Code	Description of the Error	Malfunction	Probable Cause	Solution(s)
E 01	Intervention of exhaust Thermostat (Open Combustion Chamber boiler)	Boiler does not work, E01 error code flashing on the screen	> Flue Sensor faulty	1-) Reset & Restart boiler 2-) Call for authorised service at first
E 02	Low water pressure in the system/system parameter wrongly setted	Boiler does not work, E02 error code flashing on the screen	> Water pressure in the boiler not enough	1-) Fill the boiler 1,2-1,5 bar according to manual page 28 or 29 problem will automatically removed 2-) Check if the system pressure 1,2 - 1,5 bar from the manometer located right & bottom of the boiler 3-) If problem persist Call for authorised service 4-) Reset & Restart boiler
E 03	High water pressure in the system	Boiler does not work, E03 error code flashing on the screen	> High Water pressure in the boiler higher than > 2,8 bar	1-) Drain the boiler water until 1,2-1,5 bar according to manual page 28 or 29 problem will automatically removed 2-) Check if the system pressure 1,2 - 1,5 bar from the manometer located right & bottom of the boiler 3-) If problem persist Call for authorised service 4-) Reset & Restart boiler
E 04	Domestic heating water temperature sensor faulty	Boiler does not work on DHW mode but still work on Central heating mode, E04 error code flashing on the screen	> Domestic heating water temperature sensor faulty	1-) Call for authorised service at first 2-) Check intermittent contacts or open contacts on harness carefully 3-) Check Domestic heating water temperature sensor resistance according to page 95 at section 4.30 if its out of tolerance replace NTC 4-) Check cabling and connectors between double NTC and board 5-) Reset & Restart boiler
E 05	Central heating FLOW temperature sensor faulty	Boiler does not work, E05 error code flashing on the screen	> Central heating FLOW temperature sensor faulty	1-) Call for authorised service at first



Failure Code	Description of the Error	Malfunction	Probable Cause	Solution(s)
E 06	No ignition	Boiler does not work, E06 error code flashing on the screen	> Gas supply failure	1-) RESET boiler at first check if problem removed 2-) Check other gas devices if they are working 3-) Check main gas supply valve is open or not 4-) Check boiler gas supply valve below the boiler is open or not 5-) RESET boiler at first check if problem removed 6-) Call for authorised service at first
E 07	Safety thermostat intervention	Boiler does not work, E07 error code flashing on the screen	> Water pressure in the boiler not enough > High Water pressure in the boiler higher than > 2,8 bar > Domestic heating water temperature sensor faulty > Central heating FLOW temperature sensor faulty > Gas supply failure	1-) RESET boiler at first check if problem removed 2-) Check boiler central heating valves are open if they are closed open of all 3-) Check all radiator valves are open if they are closed open of all minimum 3 meters of radiator must be open 4-) RESET boiler and check if problem removed 5-) Call for authorised service at first
E 08	Flame circuit failure	False flame signal from combustion or electrode	> Water blockage on syphon > Electronic board	1-) Call for authorised service at first
E 09	No water circulation in the system	Boiler does not work, E09 error code flashing on the screen	> Lack of water on the system > Pump blockage > Pump failure > Pump harness > Installation blockage	1-) RESET boiler at first check if problem removed 2-) Check boiler central heating valves are open if they are closed open of all 3-) Check all radiator valves are open if they are closed open of all minimum 3 meters of radiator must be open 4-) RESET boiler and check if problem removed 5-) Call for authorised service at first
E 10	Central heating temperature RETURN sensor faulty	Boiler does not work, E10 error code flashing on the screen	> Central heating RETURN temperature sensor faulty	1-) Call for authorised service at first
E 11	Gas valve modulator disconnected	Boiler does not work, E11 error code flashing on the screen	> Gas valve harness	1-) Call for authorised service at first 2-) Check gas valve cabling between board and gas valve
E 12	DHW temperature Probe, in storage tank mode, fault	Boiler does not work, E12 error code flashing on the screen	> Domestic heating water temperature sensor in storage tank faulty	1-) Call for authorised service at first 2-) Check intermittent contacts or open contacts on harness carefully 3-) Check Domestic heating water temperature sensor resistance 4-) Check cabling and connectors between NTC and board 5-) Reset & Restart boiler
E 13	Exhaust temperature probe over-temperature alarm	Boiler does not work, E13 error code flashing on the screen	> Over temperature flue gas outlet value > 105 C°	1-) Call for authorised service at first
E 14	Exhaust (FLUE) temperature probe fault	Boiler does not work, E14 error code flashing on the screen	> Central heating FLUE temperature sensor faulty	1-) Reset & Restart boiler 2-) Call for authorised service at first
E 15	Fan failure (feedback/supply)	Boiler does not work, E15 error code flashing on the screen	> Fan harness	1-) Call for authorised service at first 2-) Check intermittent contacts or open contacts on harness carefully on fan main supply, if main supply not connected then fan will not operate and boiler will not ignite 3-) Check intermittent contacts or open contacts on harness carefully on fan PWM connection, if PWM connection not connected then fan will work at %100 capacity 4-) Reset & Restart boiler
E 16	Central heating temperature RETURN sensor faulty	Boiler does not work, E10 error code flashing on the screen	> Central heating RETURN temperature sensor faulty	1-) Call for authorised service at first 2-) Check intermittent contacts or open contacts on harness carefully 3-) Check RETURN Central heating temperature sensor resistance according to page 93 at section 4.28 if its out of tolerance replace NTC 4-) Check cabling and connectors between RETURN NTC and board 5-) Reset & Restart boiler
E 17	Temperature difference between FLOW and LIMIT NTC (Double Heating Probe) faulty	FLOW and LIMIT sensor (DOUBLE NTC) malfunction	> FLOW and LIMIT Sensor (double NTC) faulty	1-) Reset & Restart boiler 2-) Call for authorised service at first
E 19	Water flow selection with water flow meter input reading	Lack of domestic heating water on request	Wrong parameters settled on TsP menu	1-) Call for authorised service at first 2-) Only authorised service must adjust TsP Parameter P01=0 with default value
E 20	CH Overtemperature, Temperature Central Heating > TSP 81 value °C	Boiler does not work, E81 error code flashing on the screen	> Lack of water on the system > Pump blockage > Pump failure > Pump harness > Installation blockage	1-) RESET boiler at first check if problem removed 2-) Check boiler central heating valves are open if they are closed open of all 3-) Check all radiator valves are open if they are closed open of all minimum 3 meters of radiator must be open 4-) RESET boiler and check if problem removed 5-) Call for authorised service at first



Failure Code	Description of the Error	Malfunction	Probable Cause	Solution(s)
E 21	Delta Temperature Central Heating flow and Return > TSP 82 value °C	Boiler does not work, E21 error code flashing on the screen	> Lack of water on the system > Pump blockage > Pump failure > Pump harness > Installation blockage	1-) RESET boiler at first check if problem removed 2-) Check boiler central heating valves are open if they are closed open of all 3-) Check all radiator valves are open if they are closed open of all minimum 3 meters of radiator must be open 4-) RESET boiler and check if problem removed 5-) Call for authorised service at first
E 28	Maximum allowed consecutive lock-out reset reached	Usable RESET number reached.	Too many consecutive lock-out failures (followed by reset) due to other possible causes	1-) Removing power supply reset will be allowed 2-) Check the root cause of Error code to solve 3-) If fault still persists call for authorised service
E 37	Low voltage anomaly	Boiler does not work, E37 error code flashing on the screen	Low voltage < 165 VAC +/- 5% on the supply network operation mode OR During Au-TO calibration mode < 182 VAC +/- 5%	1-) Call for Electrical supply network provider 2-) Error will remove if supply voltage > 170 VAC +/- 5% 3-) If you seen seen this E37 during calibration calibration can not be complete unless supply voltage > 188 VAC +/- 5%
E 40	Wrong network frequency survey	Boiler does not work, E40 error code flashing on the screen	Wrong frequency survey out of tolerance 50 Hz +/- 5% on the supply net work	1-) Call for Electrical supply network provider 2-) Error will remove if supply frequency 50 Hz +/- 5%
E 41	Loose of flame more than 6 successive times	Boiler does not work, E41 error code flashing on the screen	> Too many domestic heat water request in short period (1 min) > Low gas pressure	1-) Call for authorised service at first
E 42	Buttons anomaly	Boiler does not work, E42 error code flashing on the screen	Wrong parameters settled on TsP menu	1-) Call For service
E 43	Opentherm communication error	Boiler does not work, E43 error code flashing on the screen after 1 minute of communication error	Opentherm line disconnected	1-) Remove energy from boiler and re energised E43 will be removed and boiler & buttons will get back to functional 2-) Replace the room unit batteries with the fresh ones and reset from room unit 3-) Check cabling between boiler and room unit and re connect if any disconnection, if connection set up successfully then connection symbol page 37 symbol 19 will be activated on the screen 4-) Call for authorised service to re connect opentherm connection
rE 44	Cumulated intermittent ignition without reaching burner ignition.	Boiler does not work, E44 error code flashing on the screen	> Intermittent contacts on harness > Hammer effect on water net > Too many request from in short time from out side room units or thermosad bridge etc.	1-) Reset & Restart boiler 2-) Call for authorised service at first
E 62	Calibration request	Boiler does not work, E62 error code flashing on the screen	> Calibration not done > Replacing board but not service key from the board dismantled > Service key damaged or disconnected > Updating Software (probable)	1-) Call For service
E 72	Delta T heating at ignition not occurred	Boiler does not work, E72 error code flashing on the screen	> FLOW OR RETURN Sensor not on position	1-) Call for authorised service at first 2-) Check RETURN and FLOW sensor on position.
E 74	Second CH temperature Probe faulty	Boiler does not work, E74 error code flashing on the screen	> FLOW and LIMIT Sensor (double NTC) faulty	1-) Call for authorised service at first 2-) Check CH temperature probe resistance (double CH ntc probe is used as high temperature limit device) according to page 94 at section 4.29 if its out of tolerance replace double NTC 3-) Check cabling and connectors between double NTC and board 4-) Reset & Restart boiler



Failure Code	Description of the Error	Malfunction	Probable Cause	Solution(s)
E 77	Absolute current values reached	Boiler does not work, E77 error code flashing on the screen	<ul style="list-style-type: none"> > Gas inlet pressure > Aging or rust on the electrode > Recirculation on fluegas path > Blokage on flue or wrong flue > Electrode position > Cabeling disconnections > Combustion calibration > Electronic board > Gas valve failiure 	1-) Call for authorised service at first 2-) Check gas supply pressure must be 20-17 mBar. Gas pressure must be in between on this values while boiler on operational 3-) Check wrong flue OR flue gas blockage 4-) Check recirculation (flue gas leak) from flue gas path to fresh air side, check flue gas sealings specially 5-) Check any problems on the ionisation electrode, (like condensation, rust etc.), and control poistioning of the electrode, if electrode poistion wrong calibrate electrode according to user manual page 118 or 119 6-) Check if the heat exchanger coils clogged or not 7-) Check for condensation on the cabling AND/OR on board 8-) Check earth connection between board and electrode 9-) Check electrode cabeling between board and electrode 10-) Check combustion CO2 or O2 values on HI and LO mode at sweeper mode according to direction of manual page 67- 70 11-) Perform Auto Calibration according to page 76 or 77 12-) If fault still persists Replace board, but use original service key from the board dismantled to keep original parameters and calibration points. If original service key not used aslo adjust P15 related to the default value of boiler power and perform Au-To calibration according to page 76 or 77 13-) if not successfull replace gas valve, and Perform Au-To calibration according to page 76 or 77 Attention: Only authorised service must perform Au-To calibration
E 78	Max regulation current value reached	Boiler does not work, E78 error code flashing on the screen	<ul style="list-style-type: none"> > Gas inlet pressure > Aging or rust on the electrode > Recirculation on fluegas path > Blokage on flue or wrong flue > Electrode position > Cabeling disconnections > Combustion calibration > Electronic board > Gas valve failiure 	1-) Call for authorised service at first
E 79	Min regulation current value reached	Boiler does not work, E79 error code flashing on the screen	<ul style="list-style-type: none"> > Gas inlet pressure > Aging or rust on the electrode > Recirculation on fluegas path > Blokage on flue or wrong flue > Electrode position > Cabeling disconnections > Combustion calibration > Electronic board > Gas valve failiure 	1-) Call for authorised service at first
E 80	Problem on electronic gas valve driver	Boiler does not work, E80 error code flashing on the screen	<ul style="list-style-type: none"> > Electronic board > Gas valve failiure 	1-) Call for authorised service at first
E 81	Lock-out for combustion problem at starting (1)	Boiler does not work, E81 error code flashing on the screen	<ul style="list-style-type: none"> > Strong flue blokage > Combustion problem > Wrong flue > Gas inlet pressure > Aging or rust on the electrode > Recirculation on fluegas path > Electrode position > Combustion calibration 	1-) Call for authorised service at first
E 82	Lock-out for combustion problem on Lawa / Lawa Plus models	Boiler does not work, E82 error code flashing on the screen	<ul style="list-style-type: none"> > Recirculation on fluegas path > Blokage on flue or wrong flue > Combustion calibration 	1-) If there is strong wind (ie.wind storm) wait until the wind storm stop then RESET the boiler 2-) IF problem persist Call for authorised service
E 83	Temporary bad combustion fault problem on Lawa / Lawa Plus models	Boiler does not work, E83 error code flashing on the screen	<ul style="list-style-type: none"> > Recirculation on fluegas path > Blokage on flue or wrong flue > Combustion calibration 	1-) If there is strong wind (ie.wind storm) wait until the wind storm stop then RESET the boiler 2-) IF problem persist Call for authorised service



Failure Code	Description of the Error	Malfunction	Probable Cause	Solution(s)
E 84	Capacity reduction for detected (supposed) low gas inlet pressure	Boiler does not work, E84 error code flashing on the screen	> Gas inlet pressure > Combustion problem	1-) If there is strong wind (ie.wind storm) wait until the wind storm stop then RESET the boiler 2-) IF problem persist Call for authorised service 3-) Check gas supply pressure must be 20-17 mBar. Gas pressure must be in between on this values while boiler on operational 4-) Check combustion CO2 or O2 values on HI and LO mode at sweep-er mode according to direction of manual page 67- 70 5-) Perform Auto Calibration according to page 76 or 77, IF combustion values are out of tolerances measured one step before Attention: Only authorised service must perform Au-To calibration
E 87	Problem on electronic gas valve circuit	Boiler does not work, E87 error code flashing on the screen	> Cabeling disconnections > Gas valve failiure	1-) Call for authorised service at first 2-) Check gas valve cabeling between board and gas valve 3-) Measure gas valve coil resistances according to manual page 92 if gas valve coils out of tolerance, then replace gas valve, and Perform Au-To calibration according to page 76 or 77 Attention: Only authorised service must perform Au-To calibration
E 88	Fault of electronic gas valve managing circuit	Boiler does not work, E88 error code flashing on the screen	> Cabeling disconnections > Gas valve failiure	1-) Call for authorised service at first
E 89	Problem on combustion feed-back signal	Boiler does not work, E89 error code flashing on the screen	> Aging or rust on the electrode > Recirculation on fluegas path > Blokage on flue or wrong flue > Electrode position > Cabeling disconnections > Combustion calibration > Electronic board > Gas valve failiure	1-) Call for authorised service at first
E 90	Unable to regulate combustion	Boiler does not work, E90 error code flashing on the screen	> Aging or rust on the electrode > Recirculation on fluegas path > Blokage on flue or wrong flue > Electrode position > Cabeling disconnections > Combustion calibration > Electronic board > Gas valve failiure	1-) Call for authorised service at first
E 92	Air compensation active	Boiler does not work, E91 error code flashing on the screen	> Possible wind precence > Aging or rust on the electrode > Recirculation on fluegas path > Blokage on flue or wrong flue > Electrode position > Combustion calibration > Min power adjustment	1-) Call for authorised service at first
E 93	Unable to regulate combustion (temporarily)	Boiler does not work, E93 error code flashing on the screen	> Aging or rust on the electrode > Recirculation on fluegas path > Blokage on flue or wrong flue > Electrode position > Combustion calibration > Gas valve failiure > Electronic board	1-) Call for authorised service at first



Failure Code	Description of the Error	Malfunction	Probable Cause	Solution(s)
E 94	Possible low gas pressure or exhaust recirculation	Boiler does not work, E94 error code flashing on the screen	<ul style="list-style-type: none"> > Gas inlet pressure LOW > Recirculation on fluegas path > Blokage on flue or wrong flue > Aging or rust on the electrode > Electrode position > Combustion calibration > Gas valve failiure > Electronic board 	1-) Call for authorised service at first 2-) Check wrong flue OR flue gas blockage 3-) Check recirculation (flue gas leak) from flue gas path to fresh air side, check flue gas sealings specially 4-) Check any problems on the ionisation electrode, (like condensation, rust etc.), and control poistioning of the electrode, if electrode poistion wrong calibrate electrode according to user manual page 118 or 119 5-) Check combustion CO2 or O2 values on HI and LO mode at sweep-er mode according to direction of manual page 67- 70 6-) Perform Auto Calibration according to page 76 or 77 7-) if not successfull replace gas valve, and Perform Au-To calibration according to page 76 or 77 8-) If fault still persists Replace board, but use original service key from the board dismantled to keep original parameters and calibration points. If original service key not used aslo adjust P15 releated to the default value of boiler power and perform Au-To calibration according to page 76 or 77 Attention: Only authorised service must perform Au-To calibration
E 95	Intermittent combustion value	Boiler does not work, E95 error code flashing on the screen	<ul style="list-style-type: none"> > Harness on electrode and earth > Aging or rust on the electrode > Electrode position > Combustion calibration 	1-) Call for authorised service at first
E 96	Flue or air suction way blockage	Boiler does not work, E96 error code flashing on the screen	<ul style="list-style-type: none"> > Blokage on flue > Blokage on air suction path 	1-) Call for authorised service at first
E 98	SW error, board start-up error fault	Boiler does not work, E98 error code flashing on the screen	> Boiler software problem	1-) Call for authorised service at first
E 99	Generic fault	Boiler does not work, E99 error code flashing on the screen	> Boiler electronic hardware problem	1-) Reset & Restart boiler 2-) Call for authorised service at first
flashing LCD	Half Power mode on Lawa / Lawa Plus models	Boiler continue to work, flashing screen boiler still operational	<ul style="list-style-type: none"> > Recirculation on fluegas path > Blokage on flue or wrong flue > Combustion calibration > Temporary wind precence 	1-) If there is strong wind (ie.wind storm) wait until the wind storm stop then keep using the boiler as it is 36 or 48 hours boiler try to remove half power mode by it self automatically by increasing power gradually. 2-) IF problem persist after 48 hours Call for authorised service

(1) Call the Authorized Service if failure continues.

(2) 81 numbered failure corresponds any blocking in the exhaust gas pipe. In such case, you should consult the authorized service technician before restarting the combi.

4.2. RECOMMENDATIONS FOR ECONOMICAL USE OF COMBI

Your combi is adjusted at ECO mode for economic use, we recommend not to change.

Correct Capacity Selection

Heat loss calculation of the combi location should be made correctly and combi capacity should comply with this calculation. Devices not having adequate capacity shall give late responses to heating requests, devices with higher capacity may cause discomfort and more fuel consumption as they more frequently opened and closed. Therefore, combi capacities should be selected according to the place used.

Insulation

Insulation of your building is the most important item reducing the heat loss and gas consumption. However, as your combi has the highest thickness insulation of its class, heat loss is minimized.

Radiators

Ensure balancing our pressure distribution of your radiator installation within the house by making reduction adjustments from radiator valves.

Placing furnitures in front of radiators prevents air circulation and causes discomfort and more fuel consumption. Reducing radiator valves of rooms not used for a long period or if thermostatic radiator valve is used, bringing to the lowest position then, closing room doors will provide saving.

Domestic Hot Water

Always adjust temperature of domestic hot water as low as possible. Adjustment of temperature adjuster as low ensures a considerable power saving. In addition, high domestic hot water temperatures cause strong calcification and that negatively affects operation of the device (for instance, longer heating periods, less flow rate).

Thermostatic Radiator Valves

You can both ensure efficiency and comfort balancing the heat distribution around the house by using Thermostatic Radiator Valves.

Room Thermostats

Your combi will operate more economically as you will have the chance to adjust requested room temperature according to comfort and economy timings via room thermostats. Thus, you can adjust temperature of your room as you wish, and also you can acquire approximately 6% power saving with every degree of temperature decrease.



Ventilation

Do not leave windows slightly open for ventilating room/rooms. In such cases, continuous heat loss will occur. Fully opening windows for a short period provides a better results should you require room ventilation. Bring thermostatic radiator valves to lowest position when ventilating rooms.

Cleaning And Maintenance

Attention: to preserve the boiler's integrity and keep the safety features, performance and reliability, which distinguish it, unchanged over time, you must at least execute maintenance operations on a yearly basis in compliance with what is stated in the relative point at "annual check and maintenance of the appliance", in compliance with national, regional, or local standards in force.

We recommend stipulating a yearly cleaning and maintenance contract with an authorized local firm.

4.3. ISSUES REQUIRED TO BE TAKEN INTO CONSIDERATION FOR WARRANTY CONDITIONS

This warranty given by Warmhaus does not cover elimination of failures arising from abnormal use of the product and also out of the warranty scope for below given situations:

1. Damages and failures occurring in devices which are not first started by Warmhaus Authorized Services,
2. Damages and failures arising from use of the product contrary to advice given in User Manual and using out of it's intended purpose.
3. Damages and failures arising from wrong type selection,
4. Damages and failures arising from maintenance and repairs performed by persons other than our Authorized Services,
5. Damages and failures occurring due to transportation, unloading, loading, storing, external physical (Crushing, scratches, fractures) and chemical factors following delivery of the product,
6. Damages and failures arising from fire and lightning,
7. Damages and failures arising from false fuel use and fuel characteristics
8. Low or excessive voltage; unearthed socket usage;
9. damages and failures arising from faulty electricity installations
10. Damages and failures arising from failing to perform timely annual maintenance
11. Damage arising from external cleaning
12. Damages and failures those may occur in the device or usage area due to other products and accessories used in a system with the device subject to the Warranty,
13. Damages and failures arising from frost/ice occurring due to using in the outdoor places (open balcony, etc.).
14. Altering the Registry Label and Warranty Certificate,
15. Damages and failures arising from using water out of the water values defined in device user guide,

Elimination of above mentioned failures shall be performed against payment.

Dear Warmhaus Customer,
we believe the importance of providing good products to you as well as rendering good services.

Recommendations and Data to be Followed:

1. When first start of your combi is done, please keep the technical service document given by the Authorized Service and a copy of device invoice and the Warranty Document approved by your Authorized Dealer.
2. Use your product according to principles of installation and operation guide.
3. Keep the "SERVICE DOCUMENT" if received from your service technician following the service taken. The Service Document will be beneficial for you in any problems those may occur in your device in the future.



TECHNICAL DATA	UNIT	Lawa 18 & Lawa Plus 18		Lawa 24 & Lawa Plus 24		Lawa 28 & Lawa Plus 28		Lawa 32 & Lawa Plus 32	
		Natural Gas	LPG	Natural Gas	LPG	Natural Gas	LPG	Natural Gas	
Gas Circuit									
Gas Supply Pressure	mbar	20	37	20	37	20	37	20	
Gas consumption at maximum heat load (Hi= 9,45 kWh/m ³)	m ³ /h	2,06	-	2,61	-	3,15	-	3,58	
Gas consumption at minimum heat load (Hi= 9,45 kWh/m ³)	m ³ /h	0,84	-	0,84	-	1,25	-	1,51	
Gas consumption at maximum heat load (Hi= 24,44 kWh/m ³)	m ³ /h	-	0,80	-	1,01	-	1,22	-	
Gas consumption at minimum heat load (Hi= 24,44 kWh/m ³)	m ³ /h	-	0,33	-	0,33	-	0,47	-	
Central Heating Circuit									
Maximum nominal CH Heat Output	kW	18,0		23,2		28		31,6	
Minimum nominal CH Heat Output	kW	7,00				10		12,0	
Maximum Heating Efficiency	%	92,5	92,50	93,9	93,77	94,06	93,68	93,36	
Minimum Heating Efficiency	%	88,1			88,0	84,41	87,96	84,10	
Temperature adjustment range	°C	35 - 80							
Maximum operating pressure	bar	3							
Minimum operating pressure	bar	0,5							
Expansion tank volume	liter	7				8	8	10	
Domestic Hot Water Circuit									
Maximum Domestic Hot Water Heat Output	kW	18,0	18,0	23,2	23,20	28	28	31,6	
Minimum Domestic Hot Water Heat Output	kW	7,00	7,00	7,00	7,00	10	10	12,0	
Max. Domestic Hot Water flow rate (Δt: 30 °C)	l/min.	8,4	8,4	10,9	10,9	13,1	13,1	14,8	
Min. Domestic Hot Water flow rate	l/min.	2,0							
Maximum water pressure	bar	10							
Minimum water pressure	bar	0,3							
Temperature adjustment range	oC	35 - 60							
Electricity Circuit									
Electricity Supply	V AC - 50 Hz	230 V +%10; -%15							
Electricity Consumption	Watt	110,0	121	110	121	136			
Protection Index	IP	X5D							
Exhaust Gas Circuit									
Nominal Exhaust Gas Temperature (DHW & CH)	°C	120	120	124,3	124,3	110	110,0	115	
Minimal Exhaust Gas Temperature (DHW & CH)	°C	96,4	96,4	96,4	96,4	84,5	84,5	86,0	
Max. Flue Mass Flow Rate (60/80°C - Qn) (DHW & CH)	g/s	13,66	-	15,10	-	18,1	-	19,7	
Min. Flue Mass Flow Rate (60/80°C - Qn) (DHW & CH)	g/s	10,30	-	10,30	-	14,0	-	15,8	
NOx	Class	3	3	3	3	2	2	2	
CO2 (60/80°C - Qn) (DHW & CH)	%	6,2	7,2	6,4	7,3	6,5	7,4	6,8	
General									
Hydraulic Group Material	Material	Brass							
Maximum Pump Head	mmH ₂ O	5,6				6,1			
Dimensions (H x W X D)	mm	725 x 420 x 288				725 x 420 x 380			
Device Weight	kg	29,3				34,5			
Packed Device Weight	kg	32,5				37,2			
Type		C12, C32, C42, C52, C82, B22, B32							
Category		I2H (G20 = 20 mbar) I2H (G20 = 13 mbar) I3P (G31 = 37 mbar)							
Maximum Flue Range (Horizontal / Vertical)*	m	5 / 6							

Notes: * In a maximum flue range, for every 90° bend; it should be reduced by 1 m and 0.5 m for each 45° bend.



GAS CATEGORIES AND COUNTRIES				
Appliance categories	Supply pressures [mbar]	Used gas	Countries of destination	Lawa 18 Lawa 24 Lawa 28 Lawa 32 Lawa Plus 18 Lawa Plus 28 Lawa Plus 32
I _{2H}	20	G20	AT, BG, CH, CZ, DK, EE, ES, FI, GB, GR, IE, IT,LT, LV, NO, PT, RO, SE, SI, SK	Yes
I _{2E}	20	G20	DE, LU, PL, RO	Yes
I _{2E+}	20/25	G25	BE, FR	Yes
I _{2L}	25	G25	NL	Yes
I _{2ELL}	20, 20	G20, G25	DE	Yes
I _{2H}	25	G20	HU	Yes
I _{3P}	37	G31	CH, CZ, ES, GB, GR, IE, RO, SI, SK	Yes
NUMBER OF CHOSED CONNECTING CONDITIONS				



All descriptions and illustrations provided in this document have been carefully prepared but we reserve the right to make changes and improvements in our products which may affect the accuracy of the information contained in this leaflet. All goods are sold subject to our standard Conditions of Sale which are available on request.

LAWA & LAWA PLUS

CONVENTIONAL COMBI BOILERS INSTALLATION & USER MANUAL

Instruction booklet code of Lawa/LawaPlus: 150.11.606.00004
Revision Date : 11.2020